

# **Flam<sup>®</sup>**

**Heating Technology**

**One Stage  
Gas Burner**

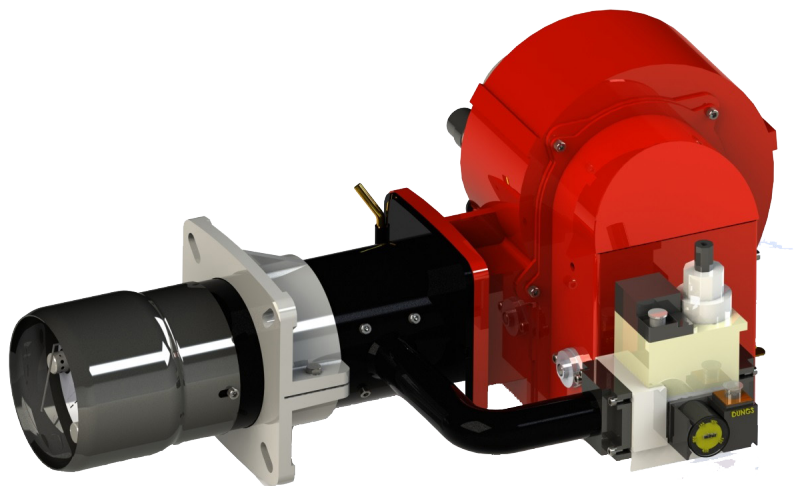

Type:

SC 0.1 GS  
SC 1.1 GS  
SC 1.2 GS  
SC 2.1 GS  
SC 2.2 GS  
SC 3.1 GS

Model:

Alfa

English

# INDEX

COMPANY PROFILE . . . . .	3
CERTIFICATES . . . . .	4
BODY TYPES . . . . .	5
PRODUCT ENCODE . . . . .	6
DECLARATION OF CONFORMITY . . . . .	7
USE THE BURNER SAFELY USER WARNING NOTES . . . . .	8
WARNING NOTES . . . . .	8
WARNING NOTES . . . . .	9
WARNING NOTES . . . . .	10
ELECTRICAL WARNING SIGNS. . . . .	11
EASY SETUP . . . . .	12
FUELS . . . . .	12
DESIGN. . . . .	12
WORKING PRINCIPLES . . . . .	12
BURNER OPERATION OPTIONS . . . . .	12
ENVIRONMENT-FRIENDLY TECHNOLOGY . . . . .	12
WORLDWIDE TECHNICAL SERVICE. . . . .	12
CUSTOMIZE SOLUTION. . . . .	12
BURNER SPECIFICATIONS . . . . .	12
FLAME SIZE AND DIAMETERS (GAS) . . . . .	13
CAPACITY CURVES. . . . .	14
CAPACITY CURVES. . . . .	15
CAPACITY CURVES. . . . .	16
BURNER DATA TABLE . . . . .	17
OPERATIONAL EXPLANATION . . . . .	18
BURNER DIMENSION TABLE. . . . .	19
EXPLODED PICTURE . . . . .	20
EXPLODED PICTURE . . . . .	21
PRODUCT INDEX . . . . .	22
PRODUCT INDEX . . . . .	23
IGNITION ELECTRODE . . . . .	24
TURBULATOR AND ITS POSITION. . . . .	24
GAS AND AIR PRESSURE SWICH. . . . .	25
Operation of Gas Pressure Switch . . . . .	25
Operation of Air Pressure Switch. . . . .	25
GAS VALVE CONNECTION . . . . .	26
BURNER EQUIPMENTS . . . . .	27
MAINTENANCE . . . . .	28
COMMISSIONING PROCEDURE . . . . .	29
PACKING . . . . .	30

# **Flam**<sup>®</sup>

---

## **Heating Technology**

Flam burner with production quality which is above the standard is one of today burners in Turkey numbered manufacturer. It works with the most experienced staff of the sector. As Flam burner, we offer high quality and reliable service as wide range of burners such as gas burners, motor burners, fuel oil burners, dual fuel burners, industrial burners, drying burners.

Being a production and sustainable brand as Turkish Market is one of our important goals. In addition, Flam Burner has proven itself in the European market and works with well-established brands such as Giersch.

Our burners are high performance. It saves fuel and energy. They are easy to deploy and maintain. The replacement parts are easy to install and our experienced service network is available.

Our burners offer the possibility of burning both gas and liquid fuel systems in the same burner. This feature of our burners will be a great advantage for you.

We can produce gas, liquid and double fuel burner in the capacity of 35000 kW / h with 100kW / h.

We work with reliable brands as Flam burner. We supply our burner components and spare parts from brands such as Dungs, Siemens, Lamtec.

The right choice of burner in the burner sector is very important. In this direction, our sales department consists of people who know what you sell for your satisfaction. To guide you right is not a sales technique but a first. As Flam Burner, our burners have low NOx values and we manufacture according to sustainable environmental policies. More environmentally friendly and economical burner designs are investments we made for our future.

Flam Burner has put its permanence in front of profit with years of experience. Our priority is to go on top of the standard required by the times.

Our goal is to go beyond your expectations and earn your satisfaction. Flam burner vision is energy-efficient and environmentally friendly advanced technology to produce high efficiency burners for your future.

## CERTIFICATES

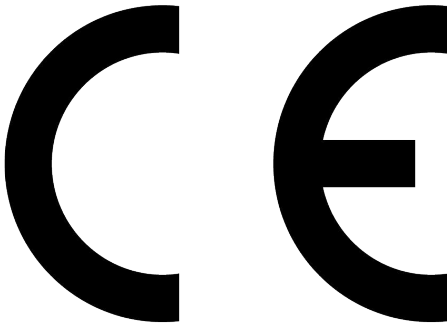

**AZS MİLLİ SERTİFİKATLAŞDIRMA SİSTEMİ**  
Azərbaycan Respublikasının Standartlaşdırma, Metrologiya  
və Patent üzrə Dövlət Komitəsi

“Gas Burner TSE, CE Design Module Production Module CE, ISO 9001: 2008 Quality Management Certificate and continue with the sales market.

“The CE Design Module, CE Production Module, ISO 9001: 2008 Quality Management Certificates and CE Certificates can be accepted for the Motor-Gas Double Fuel Burners.

“Certificates from <http://www.selkoc.com.tr/dokumanlar/>  
You can view it.

## BODY TYPES

We use up to 7,800 kW of our Alfa type body for gas, oil and gas / oil fuels.

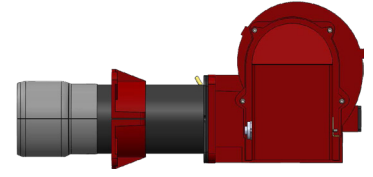

We use Beta body up to 7.800 kW in heavy oil and gas / heavy oil fuels.

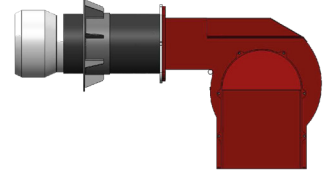

We use up to 5,000 kW of our Gamma burners in our gas-fired burners.

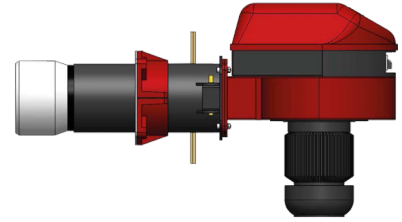

We use our Delta body in our Duoblock models from 500 kW to 7,800 kW in gas, oil, heavy oil and dual fuel.

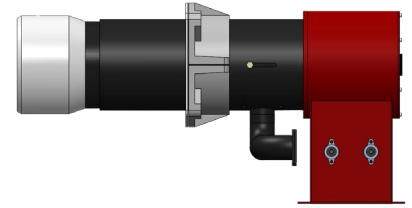

We use our Epsilon body in our Doublock models from 10,500 kW to 35,000 kW in gas, oil, heavy oil and dual fuels.

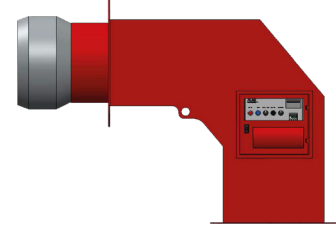

We use our Pi model from 180 kW to 500 kW in our custom ram burners.

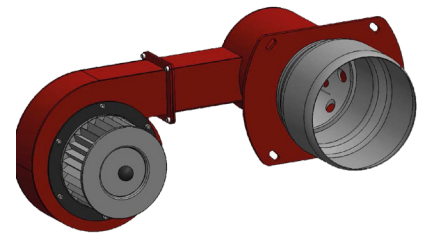

Our control panels vary according to body size and are simple to use.

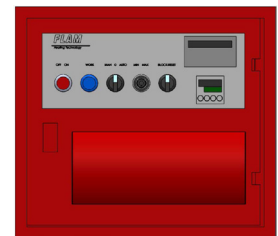

Our service network covers all of Turkey. We can send technical support to every part of the world. To our current service list.

You can find it at [www.selkoc.com.tr](http://www.selkoc.com.tr).



## PRODUCT ENCODE

# SC. 12-2-G-M-(P)-Beta

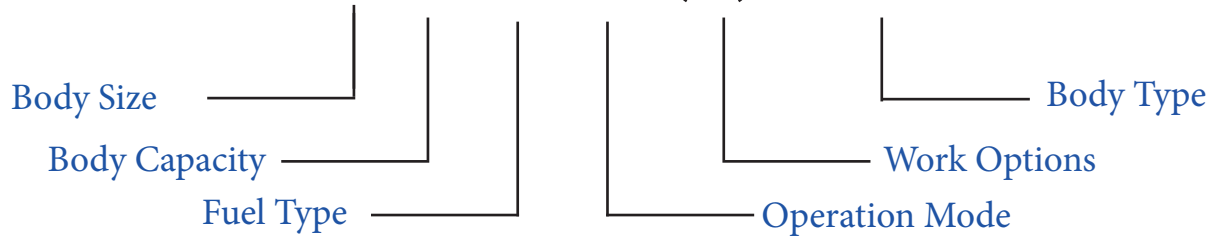

**BODY SIZE:** 0-1-2-3-5-8-10-12-14-16-18-20-22

**BODY CAPACITY:** 1-2-3

### FUEL TYPE:

G-GAS

L-LIGHT OIL

H-HEAVY OIL

GL-GAS/LIGHT OIL

GH-GAS/HEAVY OIL

### OPERATION MODE:

S-SINGLE STAGE

Z-TWO STAGE

M-MODULATING

### WORK OPTIONS:

(P)-PNEUMATIC MODULATION

(M)- MECHANIC MODULATION

(E)-ELECTRONIC MODULATION

(I)-INVERTER (Variable-Frequency Controller)

(LN)- LOW NO<sub>x</sub>

(O2) OKSIJEN TRIM

**BODY TYPE:** STATED IN THE PREVIOUS PAGE.

## DECLARATION OF CONFORMITY

Before using the burner for the first time, please ensure that the product is an integral part of this manual, which is supplied with the burner.

Read

USER'S WARNING FOR USING BURNER WITH CONFIDENCE

NOTES "section carefully. Burner and system operations must only be performed by authorized personnel

- Be sure to read the operating manual carefully before starting to operate or repair the burner.
- The power supply of the system must be disconnected before the repair on the burner starts.
- It is possible to cause dangerous accidents if the instructions are not followed strictly and the work is not carried out properly.

We hereby declare that the suitability of our "CE" marking SC series products is under our sole responsibility.

### **Description**

Gas or dual-fuel blow-domestic and industrial burners on the minimum regulations that apply European Directives:

- 90/396/EEC
- 92/42/EEC
- 89/336/EEC
- 73/23/EEC
- 98/37 EEC

and the European Standards subject to the design and testing:

- EN 676 (gaz ve çift yakıtlı, gaz tarafı)
- EN 60335-1, 2003
- EN 50165: 1997 + A1:2001 + A2:2002
- EN 55014 -1 (1994) and -2 (1997)

Control according to Directive 90/396 / EEC Gas Devices;  
CE2159 - Made by S & Q MART.

## WARNING NOTES

### USE THE BURNER SAFELY USER WARNING NOTES

#### 1. General Information

This product must only be used in accordance with its intended use by applying the specified installation and commissioning protocols. Other than intended use, death, injury and serious burning may occur.

Before using the burner for the first time, please read carefully the “USER WARNING NOTES FOR USE OF BURNER SAFETY” section of this manual, supplied with the burner as an integral part of the product. Operation of the burner and the system must only be carried out by authorized personnel. The power supply of the system must be disconnected before repair on the burner starts. It is possible to make dangerous accidents that the instructions are not followed carefully and the workings are not carried out properly.

The life time of the burner is 10 years

#### 2. Preface

These warning notes have been prepared with the aim of ensuring the healthy use of the components of the heating systems for civilian use and hot water production.

These notes illustrate how equipment with adequate reliability can be acted on with the purpose of avoiding damage caused by incorrect or faulty installations or improper and unreasonable use.

In addition, the warning notes in this manual are technically prepared on a level that end users can understand and are aimed at having users knowledgeable about safety issues.

The manufacturer is not liable for damages caused by errors in the installation or use of the product not in compliance with the manufacturer’s instructions

#### 3. General Warning Notes

The user manual is a special and necessary part of the product and must be supplied to the user. Read the warnings in the manual carefully as it contains

important information on safe use, maintenance and installation. Keep the guide where you can find it when you need it.

Materials must be installed by qualified technicians according to current standards and manufacturer’s instructions. By “qualified technicians” it is meant those who are experts on domestic heating and hot water production system components, and especially those authorized by the manufacturer. Incorrect installation can harm people, animals and equipment. The manufacturer is not responsible for such damages.

When the package is opened, check that all parts are present and undamaged. If in doubt, do not use materials and return your dealer. The packaging materials (wooden cage chests, plastic bags, foam, etc ...) Keep out of the reach of children. These materials must be collected and disposed of appropriately so as not to create environmental pollution.

Before any maintenance or cleaning, turn off the power of your device using the system switch at the mains supply, or switch off all the appliances.

If the system is faulty or if your device is not working properly, turn off your device, do not attempt to repair it or do not interfere with it. In such cases, contact the authorized service center only. Any material repairs must be made by Flam Authorized Services using original spare parts. Failure to act as above may jeopardize the safety of the equipment. Periodic maintenance must be carried out by authorized services in accordance with the operating instructions to ensure that the equipment operates correctly and efficiently.

If the hardware is sold or shipped to another user, or if the owner of the device leaves or surrenders; ensure that the operating instructions are always on the side of the unit. This way the new owner and / or installer can benefit from the guide.

Only original materials should be used for all equipment of wthe device, including optional materials or kits (including electrical equipment).

#### 4. Burners

This device should only be used in boilers for



## WARNING NOTES

applications that are connected to hot water boilers, ovens or other similar equipment and are not exposed to atmospheric agents (rain, dust, etc.). Other forms of use are inadequate and, therefore, It is dangerous.

The burner should be installed in the appropriate locations according to the regulations in force and in all cases where adequate ventilation is available to ensure proper combustion.

Do not reduce or cover the ventilation opening of the burner or the boiler room where the boiler is installed and the burner air intake grill opening, as hazardous oxide mixtures and explosive gas forms may form.

Before connecting the burner, check the information on the system feed (electrical, gas, motor, or other fuel) related information on the label on the front.

Do not touch the hot parts of the burner. Usually in the areas near to the flame and the fuel preheating system components are hot during operation of the device and remain hot for some time when the burners.

If the burner is no longer used, the following operations must be carried out by authorized technicians;

- a) Disconnecting the power supply line from the main switch, disconnecting the power supply,
- b) Closing the fuel supply using the shutoff valve and removing the valve release lever,
- c) Picking up parts of potentially hazardous parts,

### 5. Special Alerts

Check that the connection of the burner to the heat generator is secure, as it will occur in the flame combustion chamber. The following procedures are required to be tested by authorized technicians at least once a year and once before commissioning the burner;

- a) Adjustment of burner fuel level, adjustment of the capacity of the heat generator.
- b) Adjustment of the combustion air flow at least to ensure combustion efficiency of the burner at the minimum air flow rate declared by the current regulations.
- c) Check that NO<sub>x</sub> and unburned gases causing

air pollution do not exceed the permissible limit values according to the current legislation.

d) To check that the safety devices and control devices are working properly.

e) Checking the condition of the duct where the combustion products are discharged.

f) After the setting operations have been carried out, the mechanical safety locks of the adjusting devices must be made,

g) To check that the burner operating and maintenance manual is in the boiler room.

If the burner is continuously failing, do not try to reset it more than twice. Call your nearest authorized service agent to resolve the problem. According to the regulations in force, the operation and maintenance of the equipment should only be carried out by authorized services.

### 6. Electrical Connection

The equipment is only electrically safe if properly connected to the appropriate earthing line according to current electrical safety legislation. It is necessary to check that the necessary safety requirements have been fulfilled. If you are in doubt, have a certified electrician check the system. Because the manufacturer is not responsible for damage caused by poor grounding connection.

The suitability of the electrical circuits for maximum loads of the equipment must be checked by authorized services. Have the certified electrician check that proper wiring is done according to the maximum power drawn by the burner as shown on the technical labels, especially if the cable diameters are sufficient for the power drawn.

ssAccording to the current safety legislation, it is necessary to use a polarity switch to connect the main power supply.

The burner power supply must have neutral grounding. If the ionisation current is controlled from an ungrounded neutral, a connection must be made between the terminal 2 (neutral) and ground for the RC circuit.

Use of any electric parts; It is subject to compliance with the basic principles of electric

## WARNING NOTES

safety rules reported below;

- Do not touch equipment with wet or damp parts of your body.
- Don't take the electric cables.
- Do not leave your device in atmospheric (rain, sun, etc.) environments unless proper storage characteristics have been specified.
- Do not allow unauthorized persons and children to use.
- The mains power cables can not be changed by the user. If the cables are damaged, disconnect the equipment from the mains and call only authorized service personnel to replace the cables.
- If you decide not to use your device for a while, it is recommended that you disconnect all electrical equipment (pump, burner, etc.) from the electrical connection.

### **7. General Warning Notes on Gas, Motor or Other Use**

The burner installation must be carried out by authorized technicians in accordance with the existing laws. Incorrect installation may harm human beings, animals and other persons, in which case the manufacturer is not responsible for this damage.

Before installing the burner, it is recommended to clean the dirt inside the fuel supply line piping, which may prevent the system from operating properly.

For the first commissioning of the burner, have the following checks carried out by authorized services:

If you have decided not to use the burner for a while, close the valves or valves on the fuel line.

Special warning notes when using gas:

Authorized technical service:

- check the compliance of the pipeline and gas lines with the applicable laws and regulations,
- check that the gas lines are leakproof.
- Don't use gas pipes for grounding electrical appliances.
- Do not leave your device in operation when you are not using it and always keep the gas valve closed.
- When the user goes away for a while, turn off the main valve that brings the burner gas.

If you get the gas smell:

- never use a power switch, telephone or any other device that may spark;
- open the doors and windows to provide airflow to clear the air of the room;
- close the gas valves;
- ask for technical assistance.
- Do not close the ventilation openings of the spaces where gas-fired devices are located, otherwise dangerous situations may occur due to the formation of toxic and explosive mixture.

## ELECTRICAL WARNING SIGNS



CAUTION VOLTAGE



ENERGY CLOSE WITHOUT  
OPENING THE SHUTTER



DAMPER ADJUSTMENT  
(OXYGEN ADJUSTMENT)

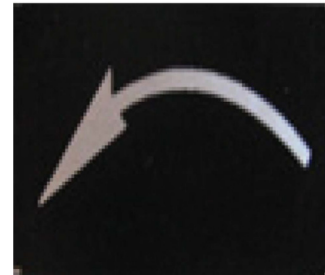

ENGINE ROTATION  
DIRECTION

## **BURNER SPECIFICATIONS**

### **EASY SETUP**

Flam borers are easy to set up with the prototype structure. It can be used with different options in ovens, dryers, generators, water and steam boilers. Horizontal and upwards can be used.

### **FUELS**

It can be used with artificial fuels like gas (G), motor (L), fuel oil (H) and other bio-gas, lpg.

### **DESIGN**

Flam burners have a modern design, maintenance and serviceability are provided for technical service.

### **WORKING PRINCIPLES**

Our burners have single and double stage and modulation options. Modulation has pneumatic and mechanical and electronics options. Modulation with the PID controller can be implemented. Our modulation ratio can be up to 1/5 of a 1/10.

### **BURNER OPERATION OPTIONS**

In our fully modulated burners we add PID control. You can also choose O2 trim, inverter and low NOx options.

### **ENVIRONMENT-FRIENDLY TECHNOLOGY**

Flam burner has reduced Nox values to European standards with its advanced technological structure and continues to work on this subject.

### **WORLDWIDE TECHNICAL SERVICE**

Our service team can serve you in every corner of the world. Dynamic and experienced gives you the promise of the best service.

### **CUSTOMIZE SOLUTION.**

Our team can offer you customize solition for your systems. Special design and calculation is our pleasure.

# FLAME SIZE AND DIAMETERS (GAS)

GAZ YAKIT - ALEV BOYU

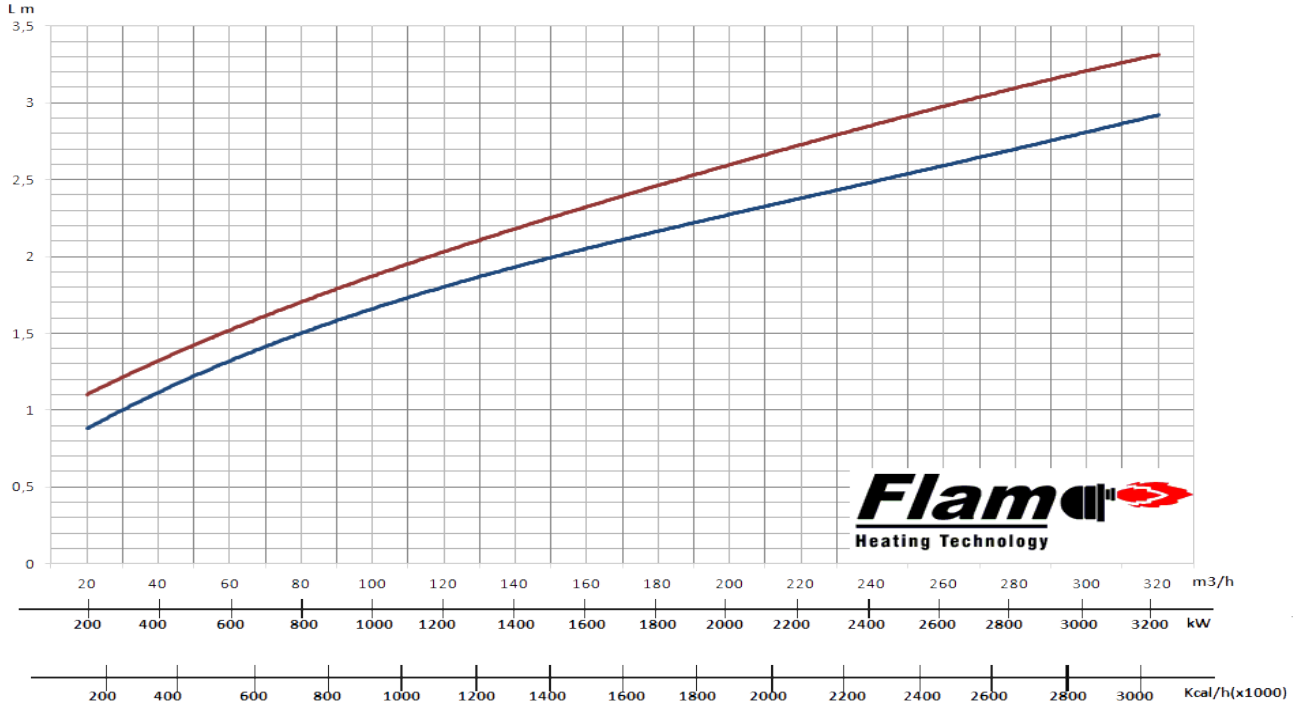

GAZ YAKIT - ALEV ÇAPI

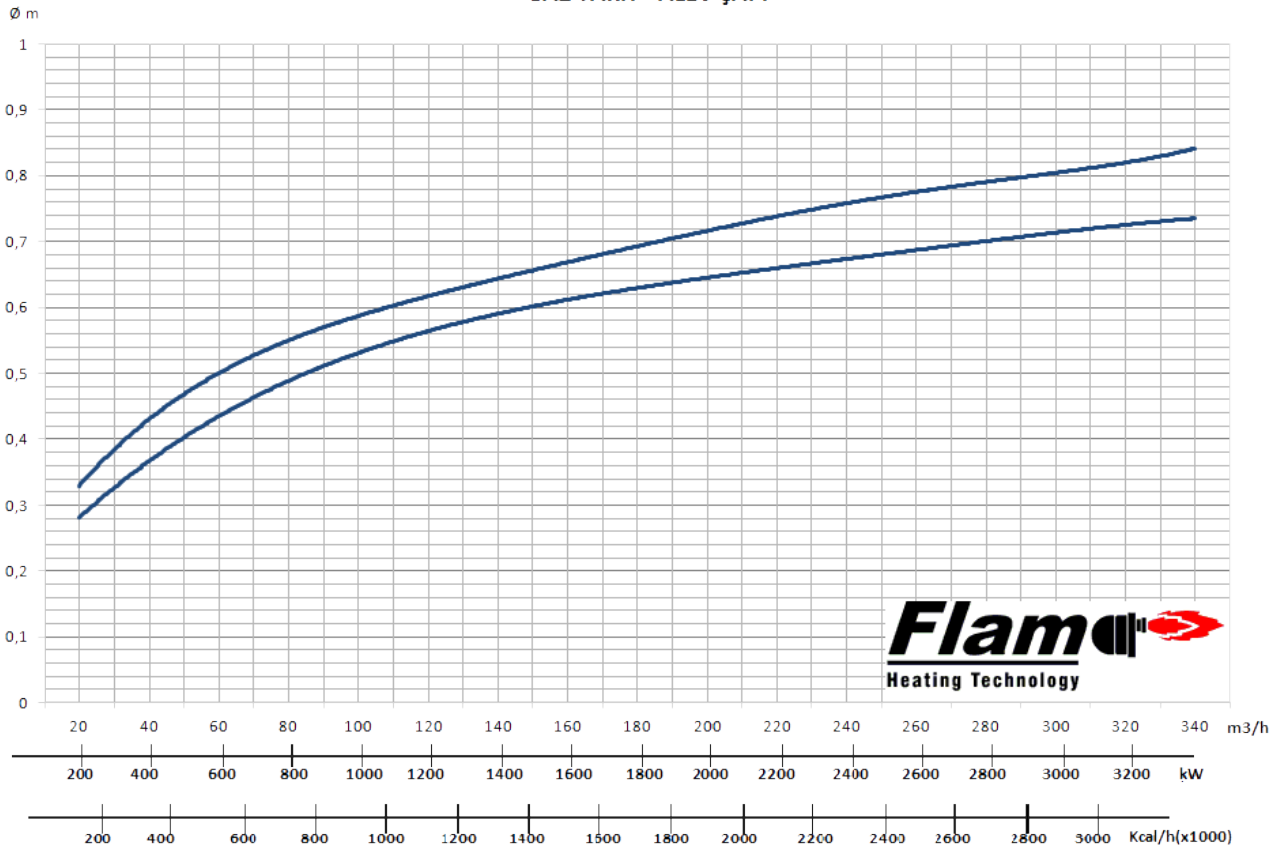

# CAPACITY CURVES

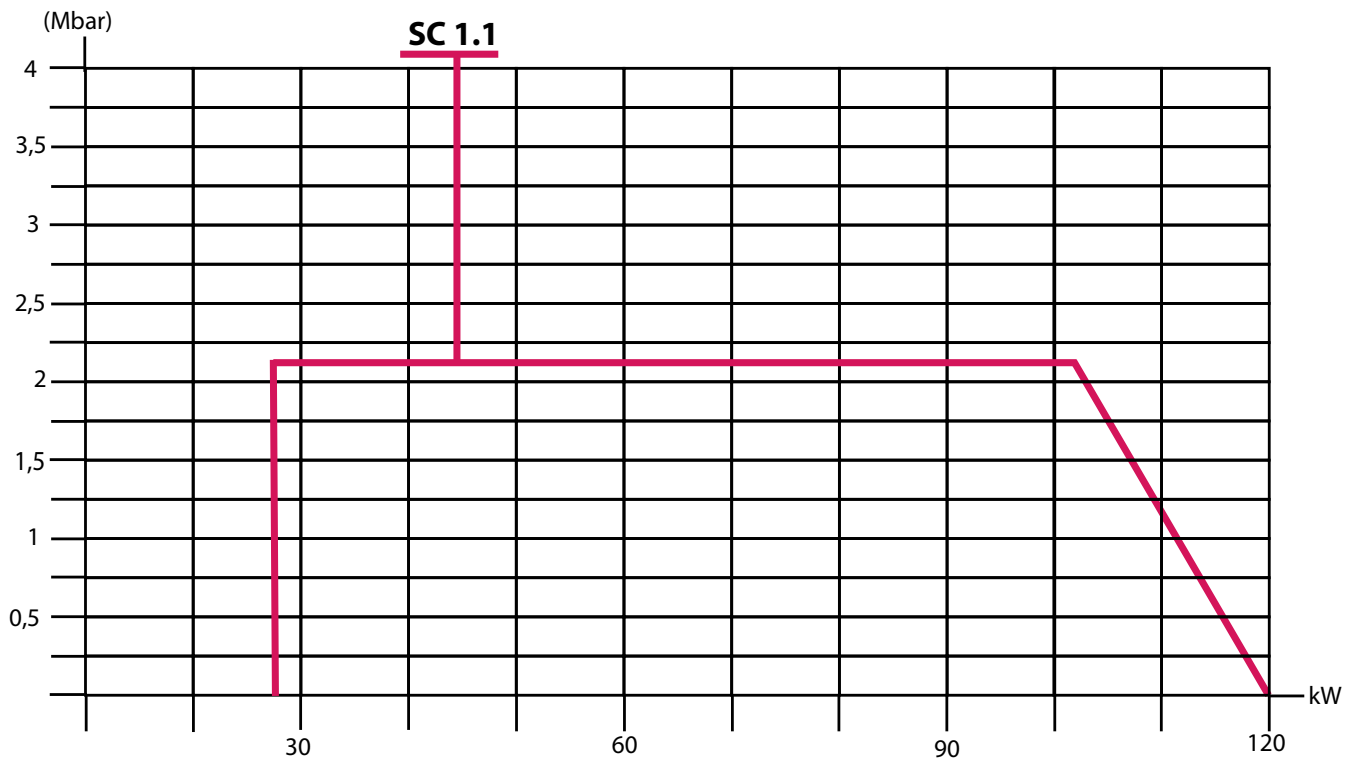
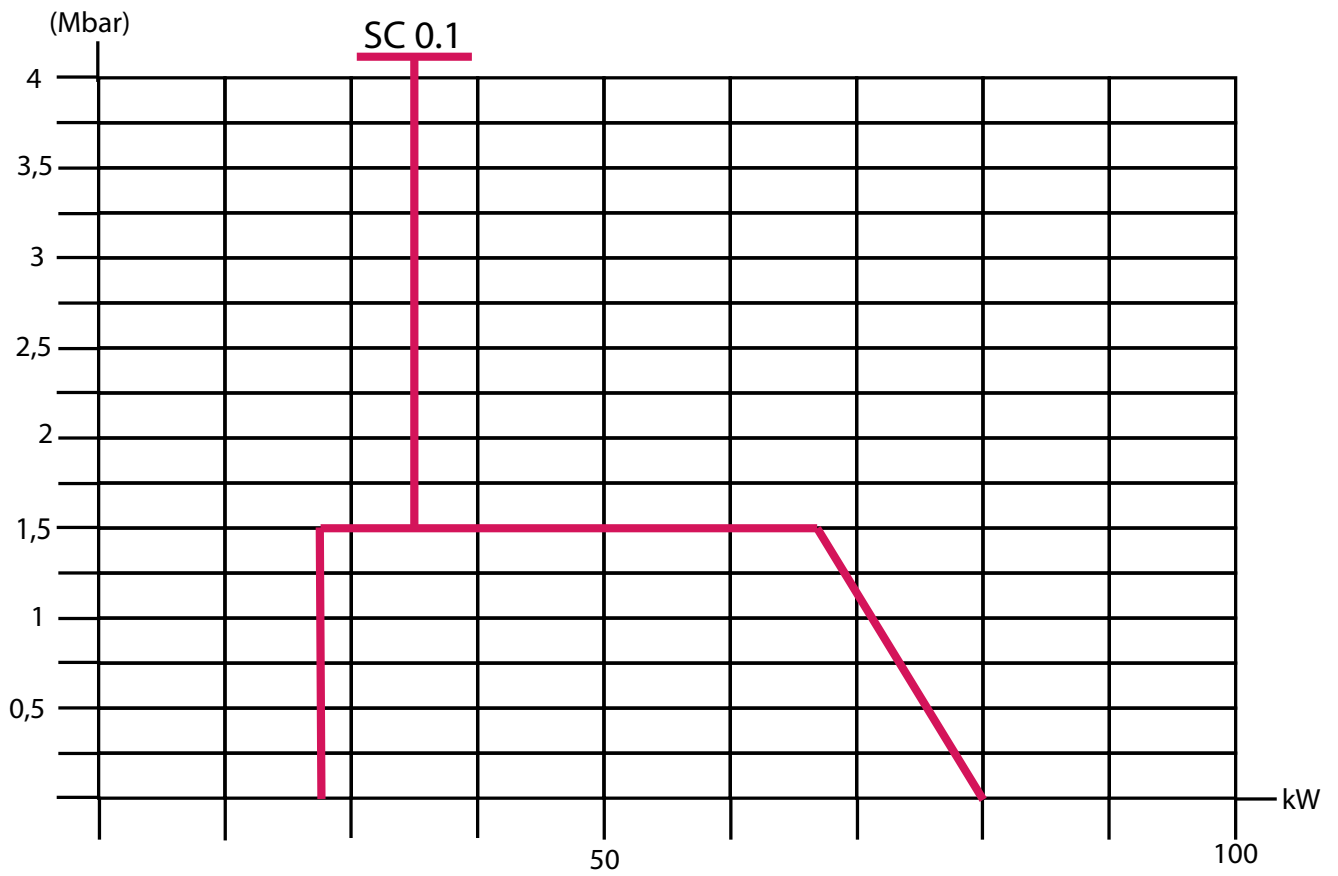

# CAPACITY CURVES

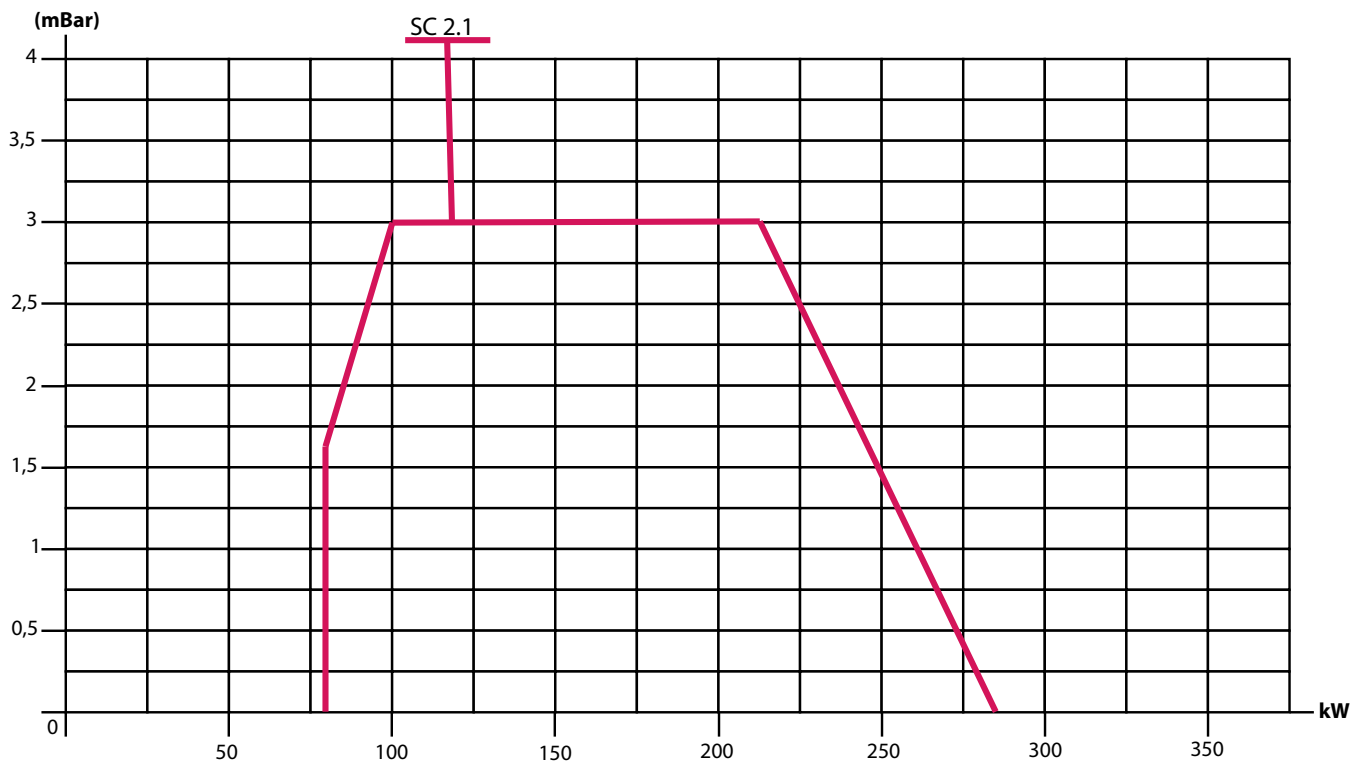
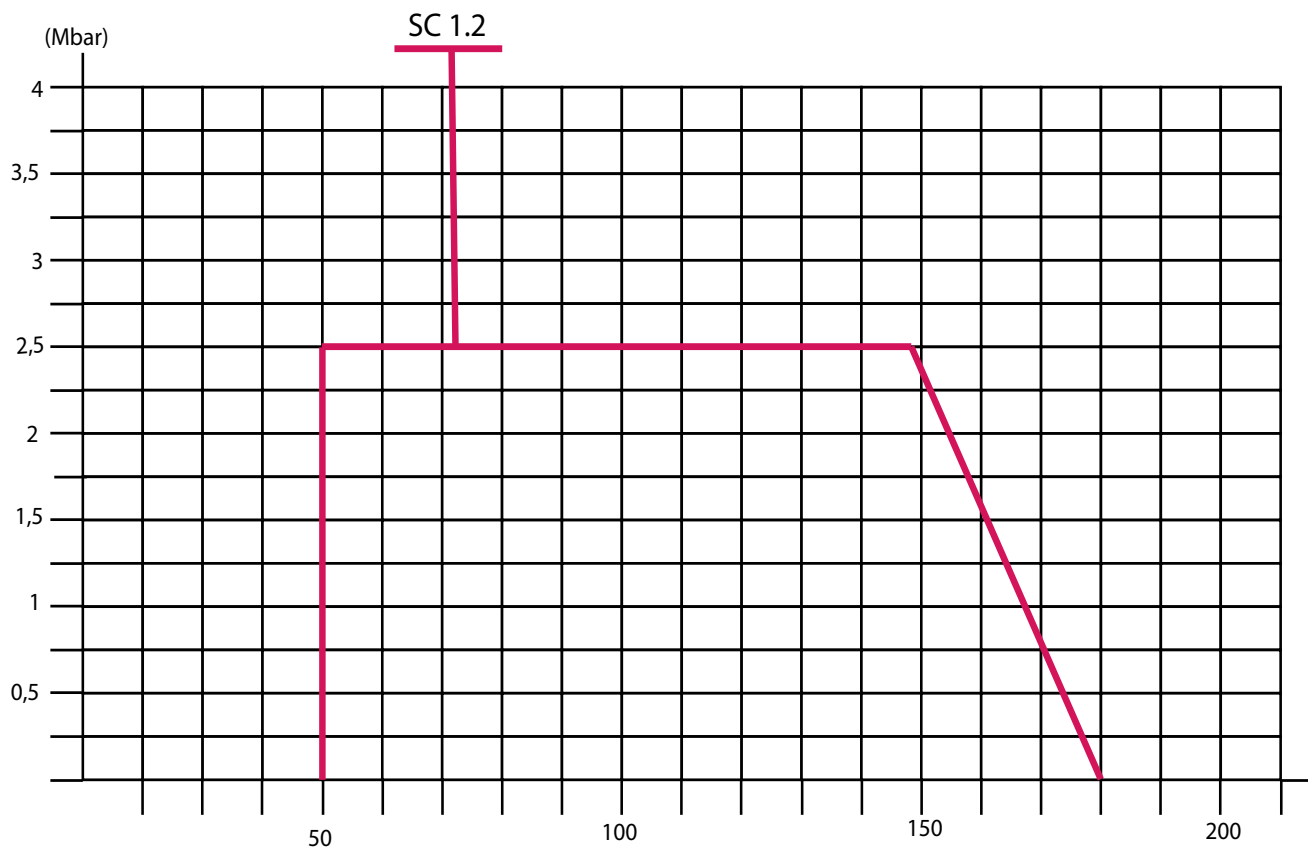

# CAPACITY CURVES

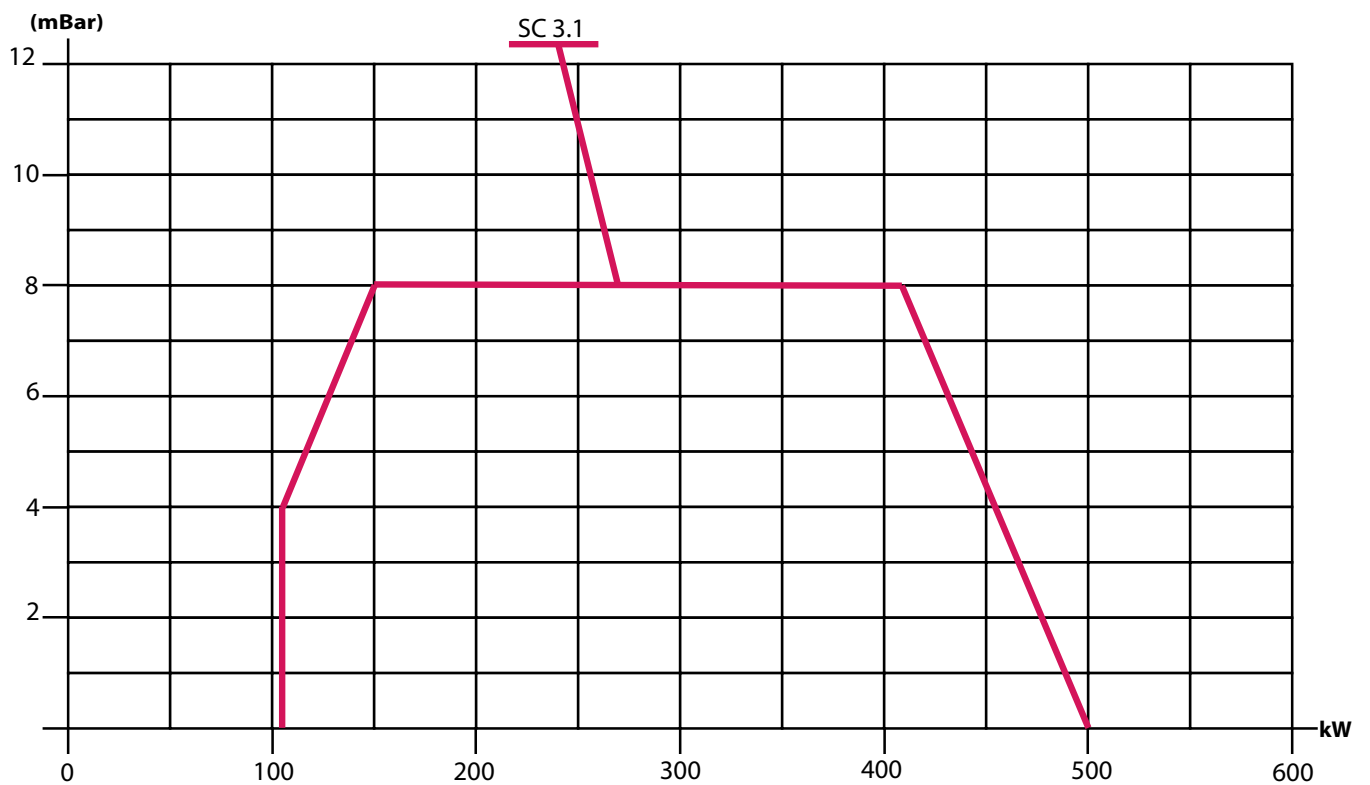
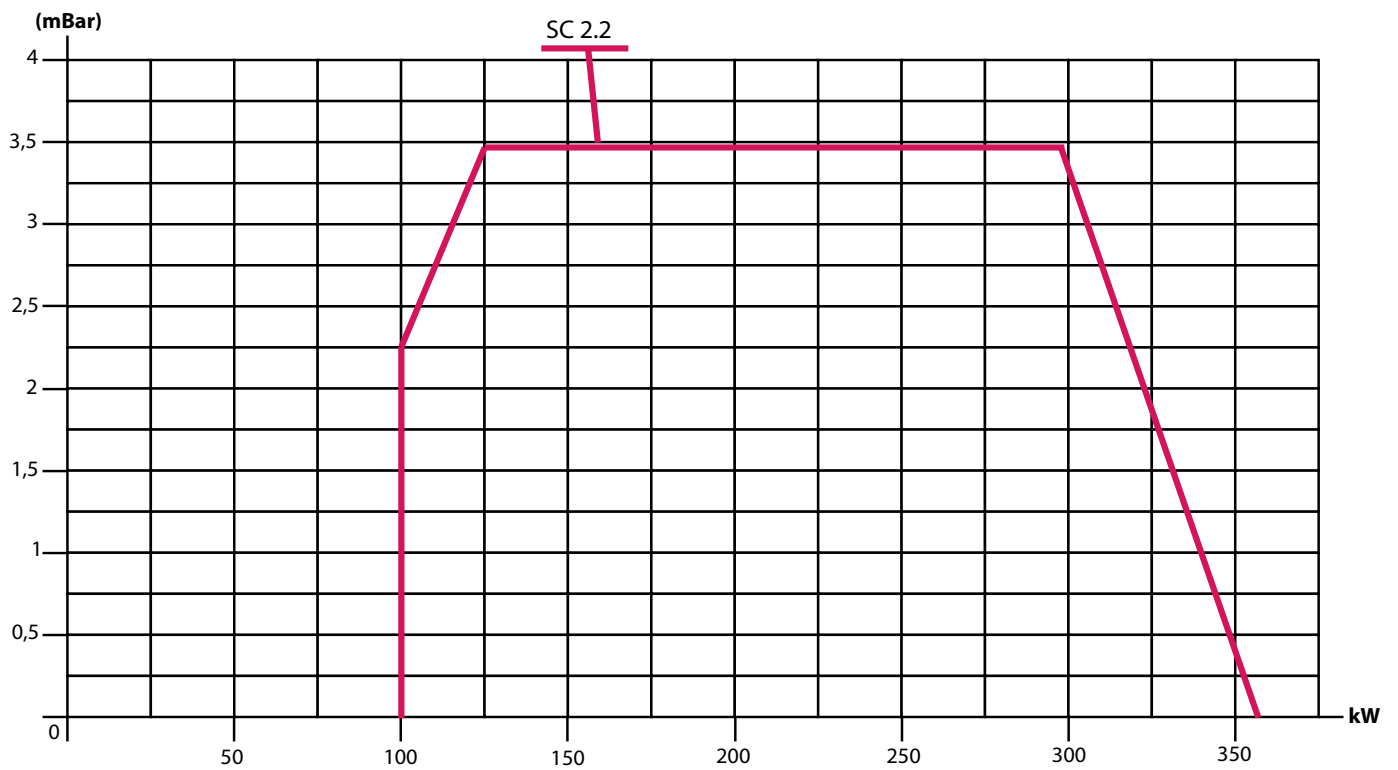



## BURNER DATA TABLE

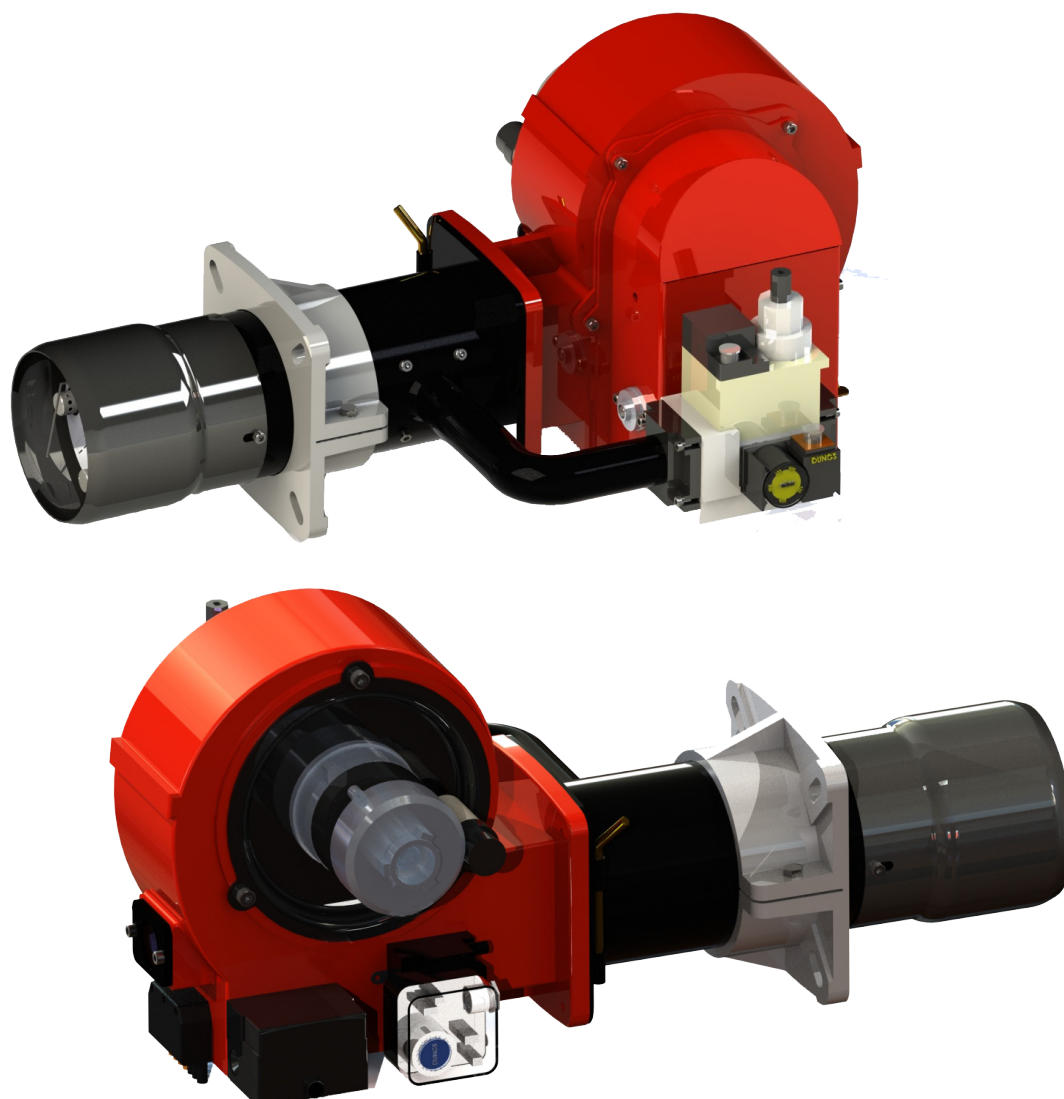

TYPE	CAPACITY						Power Supply	Motor kw	Gas Input Pressure (mbar)
	kW		kcal/h		m3/h				
	min-max	min-max	min-max	min-max					
SC 0.1 GS	10	80	8.600	64.500	1,04	7,82	1N -50 Hz 230V	0,15	21-300
SC 1.1 GS	18	120	15.480	103.200	1,88	12,51	1N -50 Hz 230V	0,15	21-300
SC 1.2 GS	50	180	43.000	154.800	5,21	18,76	1N -50 Hz 230V	0,15	21-300
SC 2.1 GS	80	280	68.800	240.800	8,34	29,19	1N -50 Hz 230V	0,25	21-300
SC 2.2 GS	100	360	86.000	309.600	10,42	37,53	1N -50 Hz 230V	0,25	21-300
SC 3.1 GS	110	500	94.600	430.000	11,47	52,12	1N -50 Hz 230V	0,37	21-300

## OPERATIONAL EXPLANATION

By switching off the main switch, if the thermostats are closed, it will reach the voltage box and after a short time, the burner will switch on according to the ignition program. The fan motor will start and function and will pre-sweep the combustion chamber. Then, the control box drives the energy to the ignition transformer and after a while, the safety valve and the working valve are opened. When the flame is formed in this way, the flame detector detects flame. The control box allows the ignition program to continue and pass the ignition phase. If a flame fault occurs, the control box performs a "safe stop" (blocking) function after 2 seconds after opening the gas valves. When "Safe Close" occurs, gas valves (safety and operation valves) are instantly turned off. Press the key on the control panel to remove the control box from its safe position. Press the maximum 3 times.

NOTE: The burner 2 has a switch to pass from 1st stage of step manual control.

- 1) Check that there is water in the boiler and open the gate valves of the system.
- 2) Be absolutely sure that the combustion products can easily come out (the boiler outlet and the boiler are open).
- 3) Check that the current, voltage and power values to be connected are appropriate for the burner required values and the electrical supply voltages of the electrical connections (motor and mains). The electrical connections will be made according to our electrical cycle. Turn off the 1st stage / switch in the burner to prevent it from moving to the second flame stage.
- 4) (depending on the boiler type) If the refractory lining of the combustion chamber, according to the instructions supplied by the boiler manufacturer burner head circumference must be lined with refractory material.
- 5) The electrical supply of the burner must be made according to the electrical connections arranged on the burner for the input voltages and as shown in our circuit diagram.
- 6) Fuel line piping must be done according to the schematic.

7) Make sure that the nozzle with the proper characteristics is fitted. Replace with the appropriate one if necessary. In no case should the fuel flow in the furnace be greater than the maximum permissible output for the burner and the maximum required for the furnace. The nozzle spray angle should be sufficient to avoid problems (vibrating flame, dirty and burning head contamination, improper commissioning, etc.).

8) Make sure that the burner head is inserted into the combustion chamber according to the instructions of the boiler manufacturer.

## BURNER DIMENSION TABLE

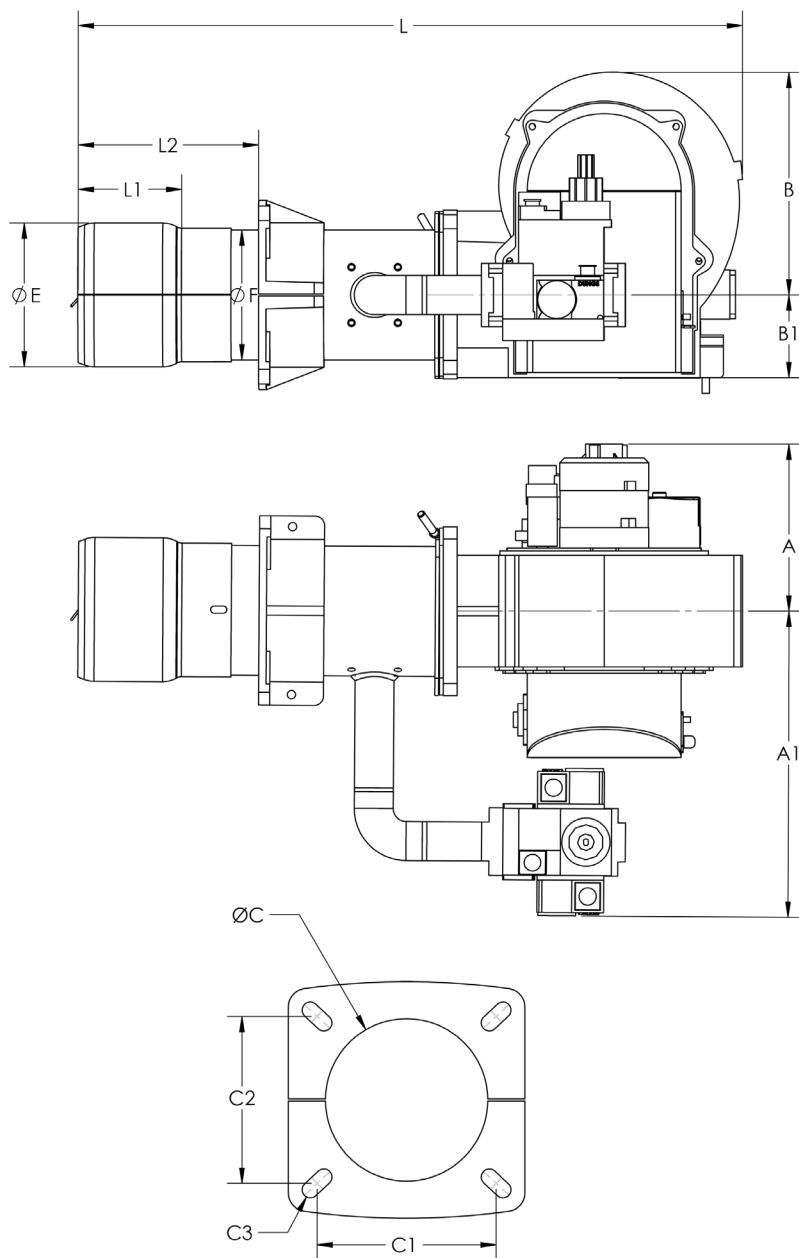

	A1	A2	B1	B2	$\varnothing C$	C1	C2	$\varnothing C3$	$\varnothing E$	$\varnothing F$	L1	L2	L
SC 0.1 GS	160	190	200	65	90	110	104	M6	90	90	78	180	415
SC 1.1 GS	180	170	210	70	90	110	104	M6	90	90	78	180	490
SC 1.2 GS	180	170	210	70	114	130	125	M8	114	114	110	160	560
SC 2.1 GS	280	300	240	90	114	130	125	M10	114	114	110	160	670
SC 2.2 GS	280	300	240	90	140	155	142	M12	145	140	110	330	690
SC 3.1 GS	280	320	290	110	140	155	142	M12	155	140	130	330	940

# EXPLODED PICTURE

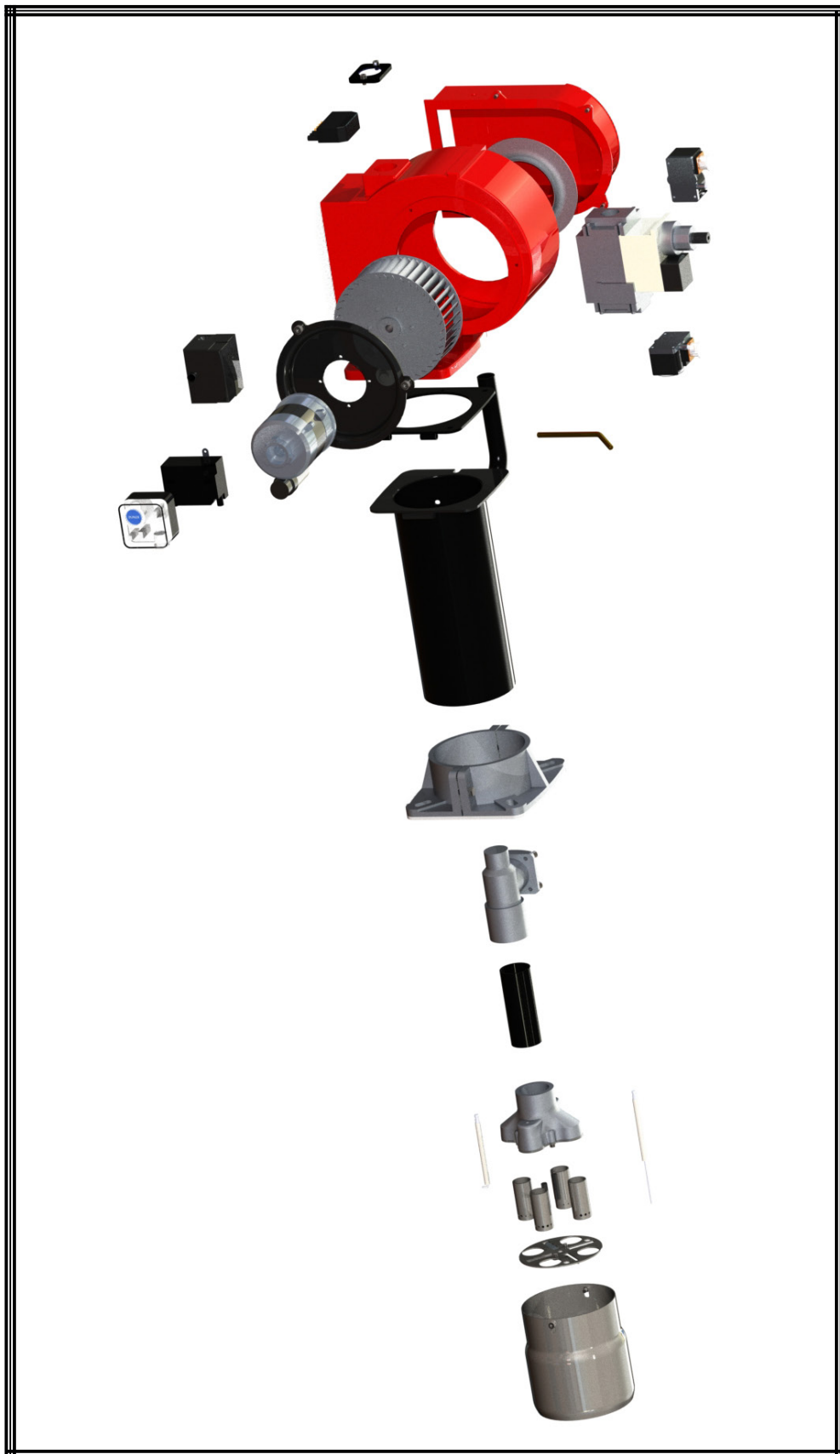

# EXPLODED PICTURE

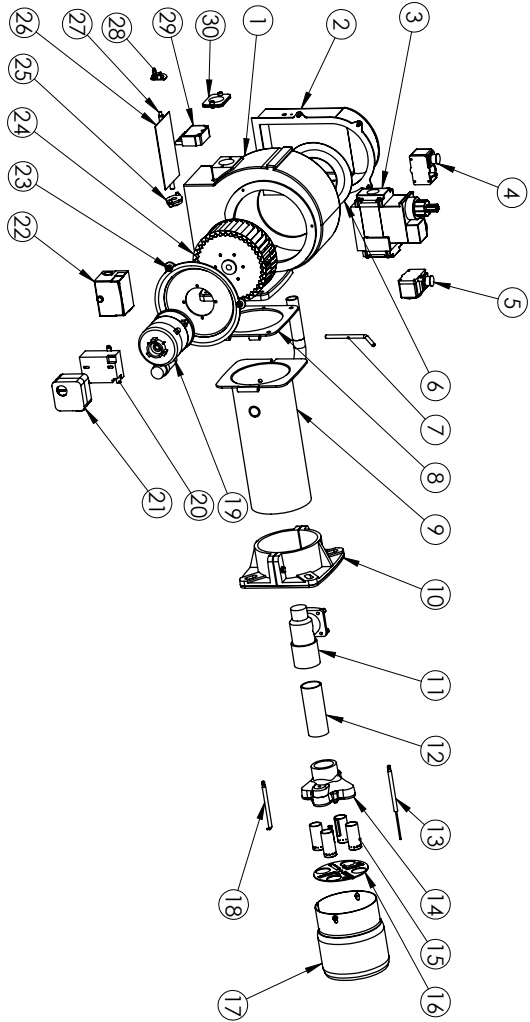

PARÇA NO	PARÇA ADI	ADET
1	BURNER BODY	1
2	BURNER AIR CLOSURE	1
3	MULTIBLOCK GAS VALVE	1
4	MIN GAS PRESSURE PRESOSTATI	1
5	MAX GAS PRESSURE PRESOSTATI	1
6	AIR SUPPLY NETWORK	1
7	AIR SUPPLY NETWORK	1
8	NAMLU HINGE FLANGE	1
9	BARREL	1
10	SLIDING FLANGE	1
11	GAS BREAKER	1
12	GAS PIPE	1
13	IONIZATION ELECTRODE	1
14	OCTOPUS	1
15	GAS BREAST	4
16	DIFFUSER	1
17	COMBUSTION HEAD	1
18	IGNITION ELECTRODE	1
19	BURNER FAN MOTOR	1
20	IGNITION TRANSFORMER	1
21	Air switch	1
22	SIEMENS LME 22 BRÜLÖR BOX	1
23	FAN ENGINE FLANGE	1
24	BURNER FANI	1
25	ROLLER	1
26	AIR CLAPPER SHEET	1
27	AIR ADJUSTMENT SCALE	1
28	HAVA AYAR SKALASI	1
29	ZILSOCKET	1
30	SIGHT GLASS	1

## PRODUCT INDEX

No	Piece Name	Piece	GS	GZ	GM(M)	GM(P)	GM(E)
1	Burner Body	1	1	1	1	1	1
2	Burner Side Clap	1	1	1	1	1	1
3	Fan Motor and Engine Flange	1	1	1		1	1
4	Burner Fan	1	1	1	1	1	1
5	Burner fan suction mouth	1	1	1	1	1	1
6	Siemens AGK11 Socket	1+1	1	1	1	1	1
7	Siemens LME 22.. Control Box	1	1	1	1	1	x
8	Siemens LFL.1 Control Box	1	x	x	1	x	x
9	Siemens LMV27.100x2 Control Box	1	x	x	x	x	1
10	Dungs LGW3A2 Air Pressure Switch	1	1	1	1	1	1
11	Beru 2x7,5 Tranformer	1	1	1	1	1	1
12	Barrel Gas Connection Pipe	1	1	1	1	1	1
13	Reduction	1	1	1	1	1	1
14	Dung MB-DLE	1	1	x	x	x	x
15	Dungs MB-ZRDLE	1	x	1	x	x	x
16	Dungs DMV-DLE	1	x	x	1	1	1
17	DungsGW500A5Max Gas pressurestat	1	1	1	1	1	1
18	Valve Shaft and Ball Bearing	1	1	1	1	1	1
19	Air Flape Plate	1	1	1	1	1	1
20	Monitoring flame	1	1	1	1	1	1
21	Siemens SQN31.121.A2700	1	x	1	x	x	x
22	Siemens SQN31.251.A2700	1	x	x	1	1	x

## PRODUCT INDEX

No	Piece Name	Piece	GS	GZ	GM(M)	GM(P)	GM(E)
23	Siemens SQN33.511.A9 Servomotor	2	x	x	x	x	1
24	7 Socket	2	1	1	x	x	x
25	4 Socket	2	x	1	x	x	x
26	Barrel Flange Shaft	1	1	1	1	1	1
27	Barrel Flange	1	1	1	1	1	1
28	Barrel Flange Gasket	1	1	1	1	1	1
29	Barel	1	1	1	1	1	1
30	Boiler Flange	1	1	1	1	1	1
31	Ambient	1	1	1	1	1	1
32	Combustion head	1	1	1	1	1	1
33	Gas sleeve	1	1	1	1	1	1
34	Gas pipe	1	1	1	1	1	1
35	Electrode Clamp	2	1	1	1	1	1
36	Nozzle Holder	1	1	1	1	1	1
37	Gas breast	4	1	1	1	1	1
38	Gas Mixing Group	1	1	1	1	1	1
39	Electrode	1	1	1	1	1	1
40	Ionization rod	1	1	1	1	1	1
41	Cam Group	1	x	1	1	x	x
42	Join Stick	1	x	1	1	x	x
43	SKP 75	1	x	x	x	1	x
44	SKP 15	1	x	x	x	1	x

## IGNITION ELECTRODE TURBULATOR AND ITS POSITION

The position of the ignition electrode and the turbulators is important to ensure proper combustion. The distance of the ignition electrode to the pilot gas bubble and the distance between the turbulator and the bushes must be specified.

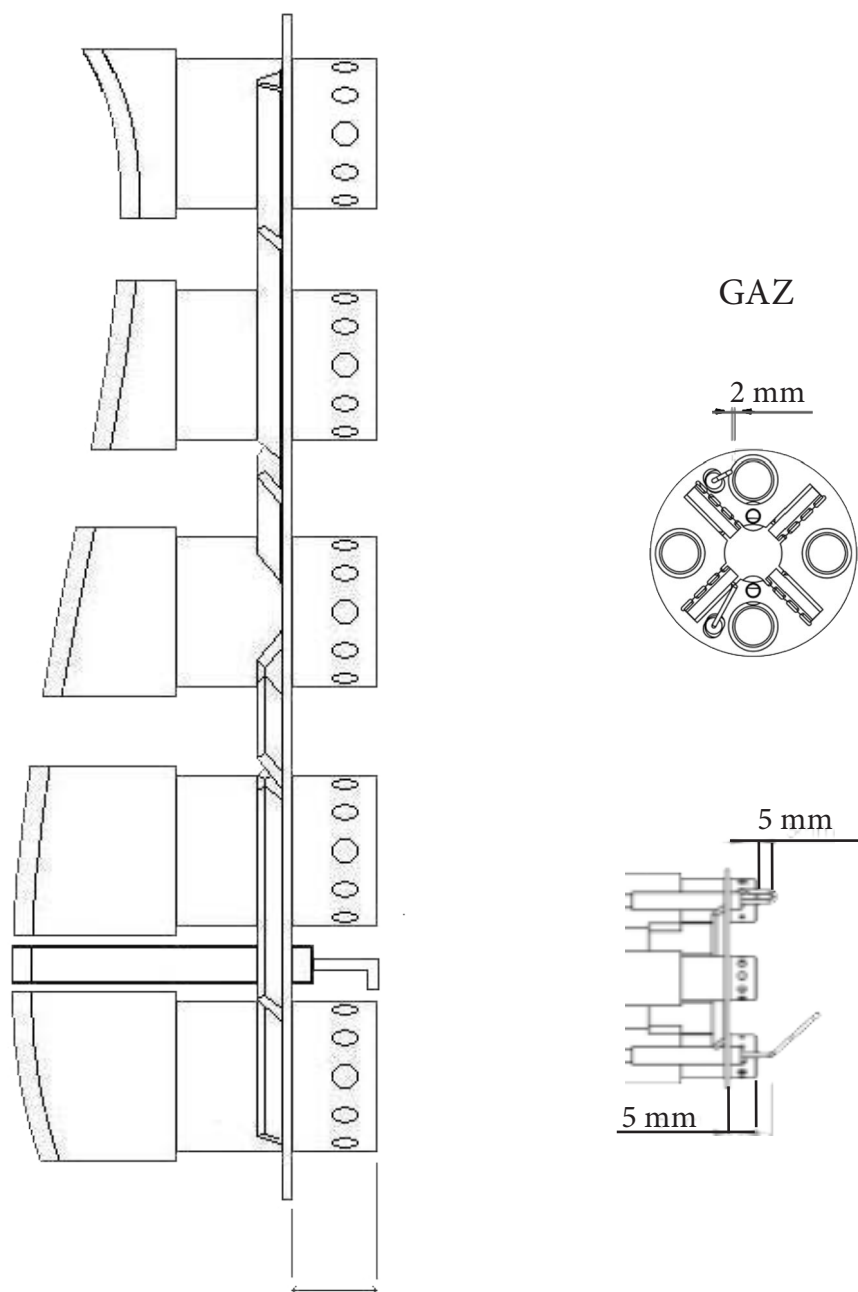

The specified distance is valid for single electrode models. For models with dual ignition electrodes, the distance between the two electrodes should be 3 mm. The distance between each of the electrodes should not be less than 4 mm.



## Operation of Gas Pressure Switch



Adjust the minimum gas pressure switch after all other burner settings have been made with the pressure switch scale set at the beginning.

## Operation of Air Pressure Switch



Adjust the air pressure switch after you have made all other burner settings with the air preostostion scale (A) set to the beginning. When the burner is operating in the first stage, increase the adjustment pressure by turning the respective knob clockwise until the burner stops. Then turn the knob from the set point to about 20% counter-clockwise and run the burner again to check the accuracy. If the burner stalls again, turn the knob a little further, as opposed to clockwise. Caution: As a rule, the air pressure limits the CO in the flue gas to be less than 1% (10,000 ppm). To check this, connect a gas analyzer to the flue gas, slowly turn off the fan suction (eg with a carton piece) and see that the burner stopped before CO 1% in the flue gas. If the air pressure switch is connected to two pipes, it can also work as a differential. If the negative pressure in the combustion chamber during pre-sweeping prevents the air pressure switch from entering the circuit, it can be done by putting a second conduit between the switching air pressure and the suction of the fan. In this way, the air pressure switch works like a differential switch. Caution: Differential operation of the air pressure switch is only allowed in industrial applications and where the air pressure switch of the rules permits only the fan to operate without any CO limit.

## GAS VALVE CONNECTION

### **MULTI-BURNER, PRESSURE GAS PIPELINE CONNECTION DIAGRAM IN THE INTERMEDIATE LEVEL**

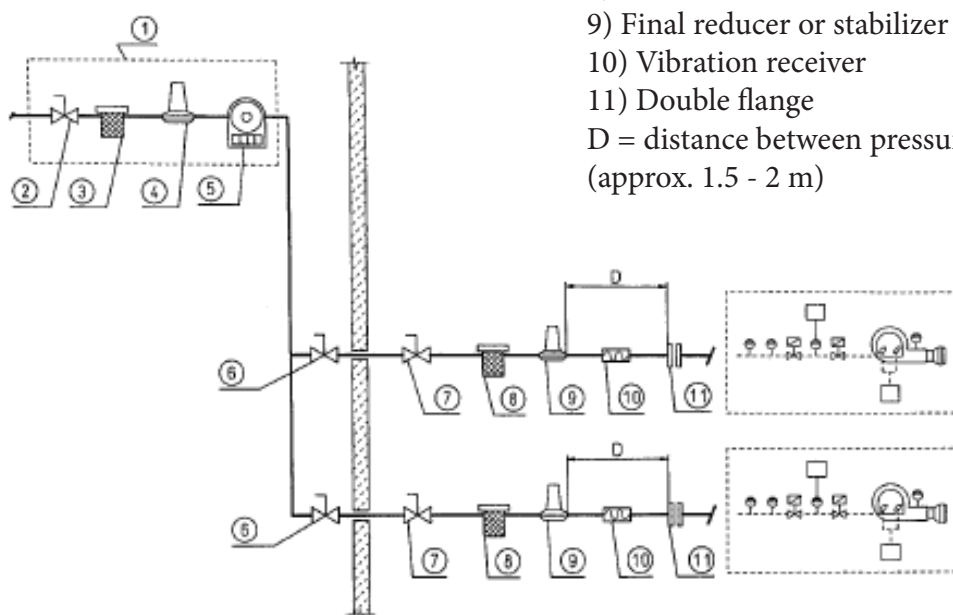

- 1) Measuring and dropping unit
  - 2) Cutting valve
  - 3) Filter
  - 4) Reducing
  - 5) Counter
  - 6) Emergency shut-off valve (installed outside the building)
  - 7) Ball valve
  - 8) Filter
  - 9) Final reducer or stabilizer
  - 10) Vibration receiver
  - 11) Double flange
- D = distance between pressure stabilizer and flange (approx. 1.5 - 2 m)

### **A BURNER'S MEDIUM LEVEL PRESSURIZED GAS PIPE HALT TO CONNECTION DIAGRAM**

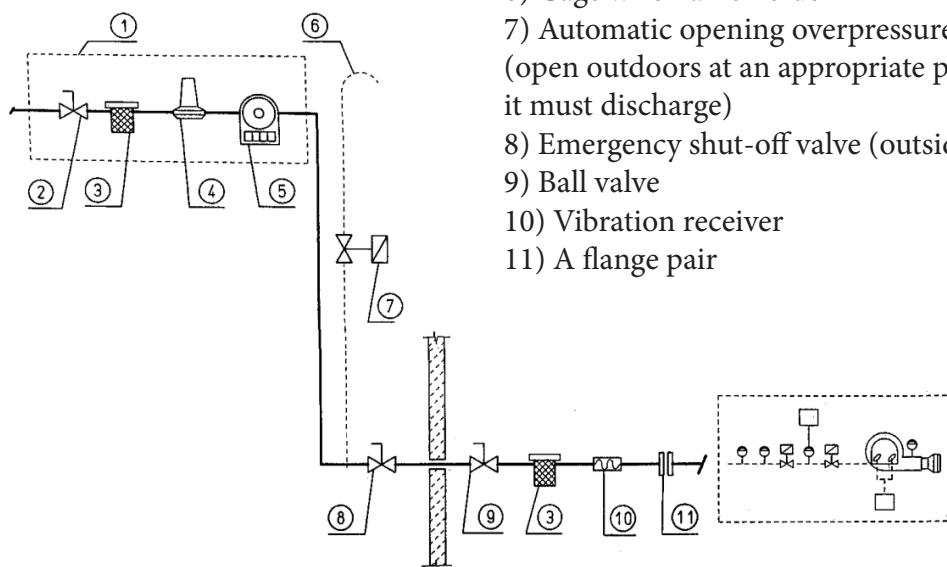

- 1) Measuring and dropping unit
- 2) Cutting valve
- 3) Filter
- 4) Reducing
- 5) Counter
- 6) Cage wire flame holder
- 7) Automatic opening overpressure relief valve (open outdoors at an appropriate place it must discharge)
- 8) Emergency shut-off valve (outside the building)
- 9) Ball valve
- 10) Vibration receiver
- 11) A flange pair

## BURNER EQUIPMENTS

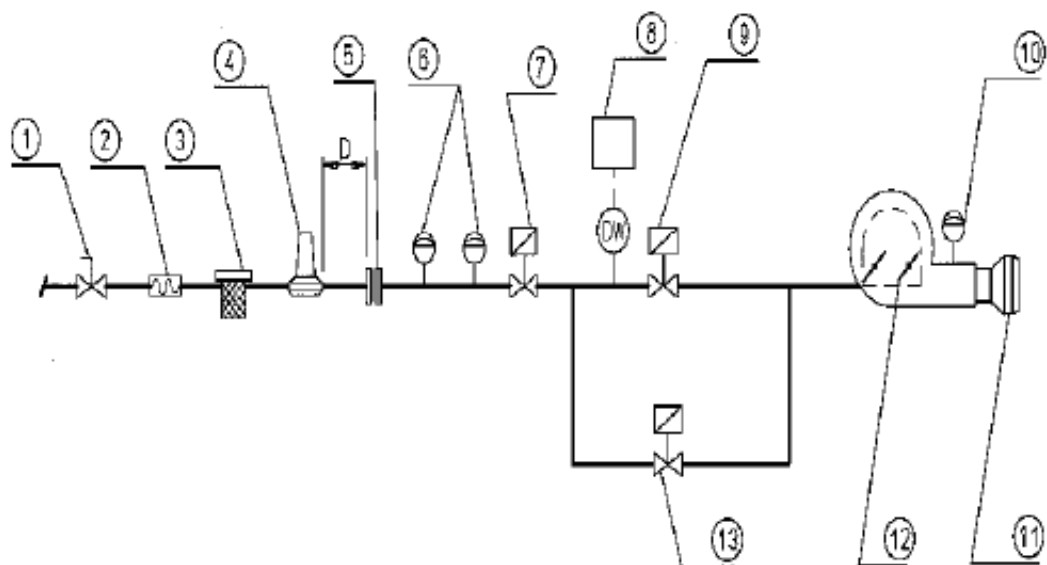

- 1 - Spherical Gas Valve
  - 2 - Vibration Receiver Connection
  - 3 - Filter
  - 4 - Regulator
  - 5 - Main gas line connection flange
  - 6 - Minimum and Maximum Gas Pressure Switches
  - 7 - Safety Gas Valve
  - 8 - If present, the valve sealing device and its switchostat (DW)
  - 9 - Main flame gas valve with flow regulator
  - 10 - Air Presostation
  - 11 - Burning Head
  - 12 - Burner fan and air adjustment clips
  - 13 - pilot flame valve with flow regulator
- D - Distance between connection flange and stabilizer should be 1,5; 2,0 meters.



### Heating Technology

- The electrical connection should be cut off first and the gas completely closed.
- The burner does not require special maintenance. However, it is a good practice to periodically check that the gas filter is clean and the ignition electrode is intact.
- In addition, it is also necessary to check the occurrence of electrode sparking between the ignition electrode and the disk.
- The combustion head may need to be cleaned.
- Center the electrodes (ignition and ionisation) precisely so that they do not touch the ground when they are put back into position and do not trip the burner.
- Most of the braking equipment can be controlled by opening the hinge.
- It is necessary to remove the mixing unit to check the head.
- The fan and turbulator should be cleaned.
- O<sub>2</sub>, CO and CO<sub>2</sub> values should be checked once a month.
- If boiler connection gaskets are damaged, they must be replaced.
- Regular maintenance of the boiler should be done.
- Smoke pipes should be cleaned once a month.
- Chimney cleaning should be done during the season passes.
- Run the boiler for summer periods, several times a month for 5 minutes, to prevent the pumps from being crushed.
- Check the air flow in the boiler room.
- Prevent the boiler chamber from getting wet. Never contact the burner with water it must not.
- Do not add water to the boiler when the boiler is hot.

## COMMISSIONING PROCEDURE

### 'Flam' Burner

The burners purchased from our company are important for the first time that the technical manager of the company who engages in the commissioning, purchasing or mechanical and electrical installation work is present during the commissioning of the burner.

The controls and works on the table below must be completed so that your burner, who has been purchased, can be activated without any problems at a time. The first start-up of our burners is done free of charge by our company or authorized service providers in Turkey.

Our company and its authorized service are not responsible for the fact that the burner can not be commissioned for the first time due to the items mentioned in the procedure or due to problems caused by the statements. The second round of commissioning visit to the facility and the first start-up activity will be carried out for the cost. The following instructions must be completed by you or your customers. When our authorized service technician arrives for the second time to your installation, you will be charged 50 Euros + VAT for each burner, 30 Euros / 100 km for the return journey and 30 Euros / 100 km for the return journey. Commissioning details to be completed before burner commissioning.

- 1 - Mechanical installation of the burner head must be done correctly.
- 2 - The burner must have provided the necessary nose piece to the boiler of the combustion head. (Min 7 - 10 cm.) (If the burner does not fit properly in the boiler shell, it may start inside the burner door and damage the boiler cover.)
- 3 - There must be thermostats on the boiler to provide boiler water temperature and one safety and one operation control to ensure safety of the burner.
- 4 - The electrical and mechanical connections of the safety and operating equipment on the device to be operated by the burner must be made to the system.
- 5 - The air of the installation should be taken by filling the system with water.
- 6 - The closed expansion tank pressure connected to the system should be adjusted according to the operating pressure of the system.
- 7 - The circulation pumps must be in operation.
- 8 - Electrical installation must be completed (Temperature sensor-Thermostat-to-burner main supply cables)
- 9 - Fuel supply has been provided and the necessary connections to the burner have been made correctly.
- 10 - If there is a gas in the burner, there should be a manometer.
- 11 - Required legal permissions have been obtained (Gas opening certificate etc.)
- 12 - If the burner is proportional controlled, the temperature sensor or pressure transmitter shall be provided and mechanical and electrical connections shall be made to the burner to provide proportional operation of the burner.
- 13-No water leakage is required in the installation.

We will be sent to our customers as a "Request Form" together with our burners. By filling out the form and sending it to us by fax or e-mail it will be delayed and problems will be prevented. It is important to inform your customers in this regard.

## PACKING

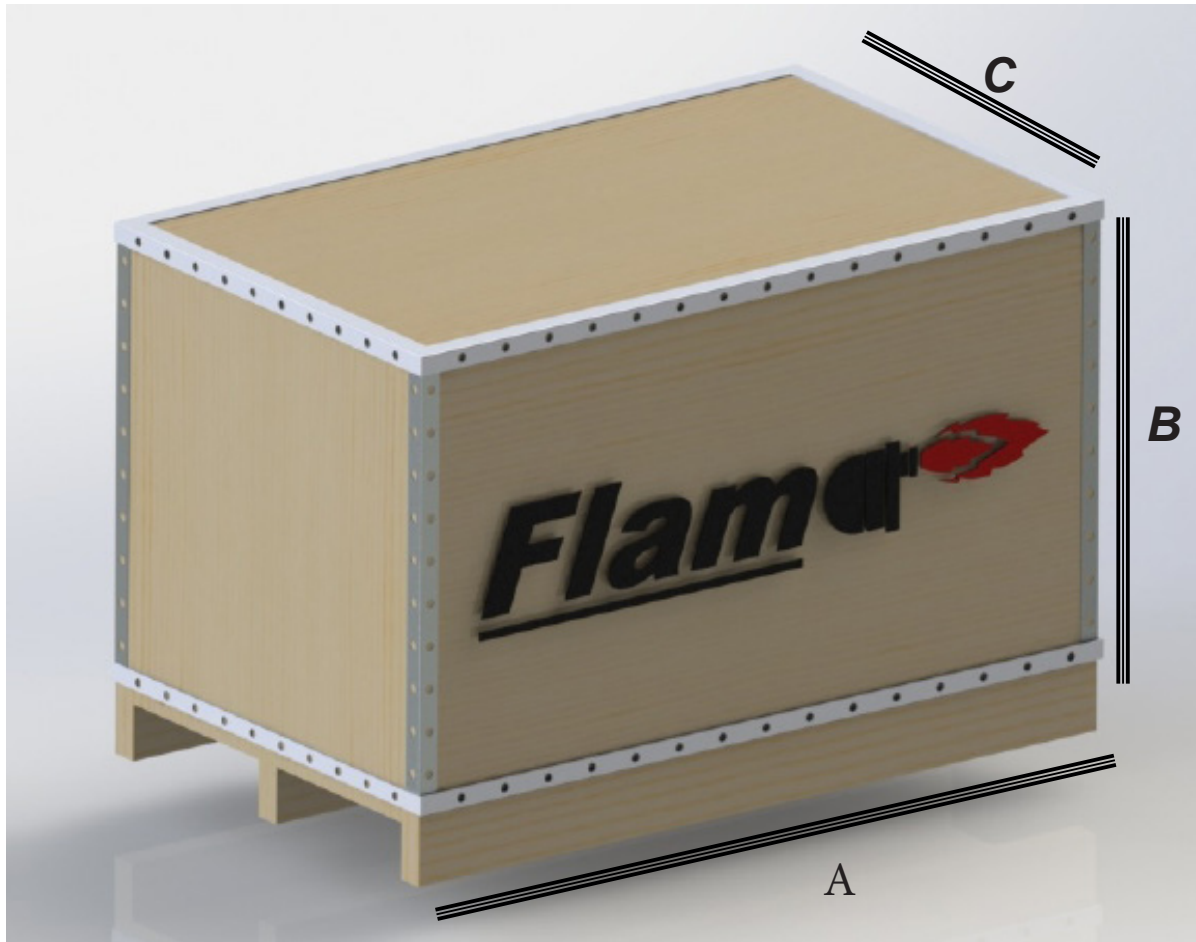

	Lenght(a)	Width(b)	Height(c)	Weight
SC 1.1 GS	68 cm	46 cm	51 cm	35 kg
SC 1.2 GS	73 cm	46 cm	52 cm	35 kg
SC 2.1 GS	79 cm	48 cm	62 cm	40 kg
SC 2.2 GS	92 cm	48 cm	62 cm	40 kg
SC 3.1 GS	111 cm	62 cm	71 cm	45 kg



**Selkoc**  
Isıtma & Soğutma Otomasyon San. Tic. Ltd. Şti.

Selkoc Isıtma ve Soğutma Otomasyon  
San. Tic. Ltd.  
Şti. İsmetpaşa Mah. Hisar Sok. Üstün İş  
Merkezi.  
No: 20/53 Tel: +90 212 501 48 54  
Fax: +90 212 501 48 57  
info@selkoc.com.tr  
www.selkoc.com.tr